

千葉県型側溝 CH1 断面図 S = 1 / 15

平面図 S=1/35

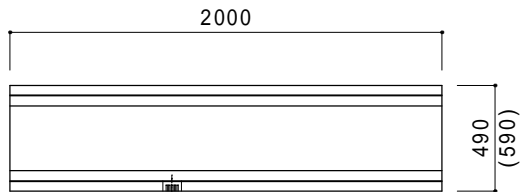

側面図 S=1/35

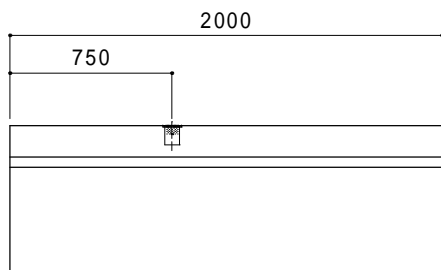

CH1-30-30

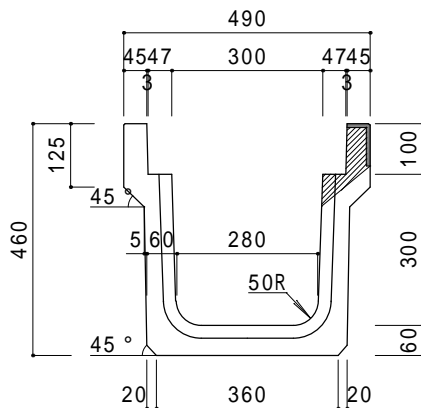

CH1-30-40

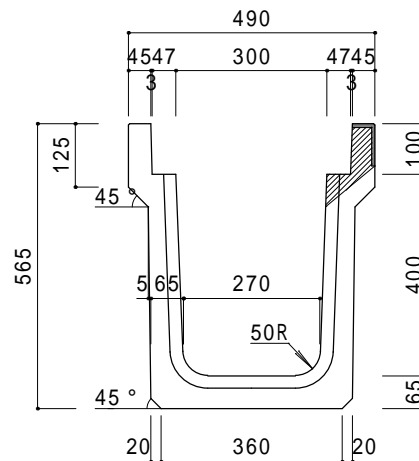

CH1-30-50

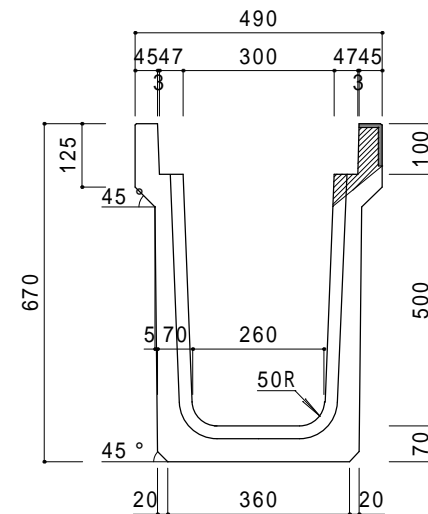

CH1-30-60

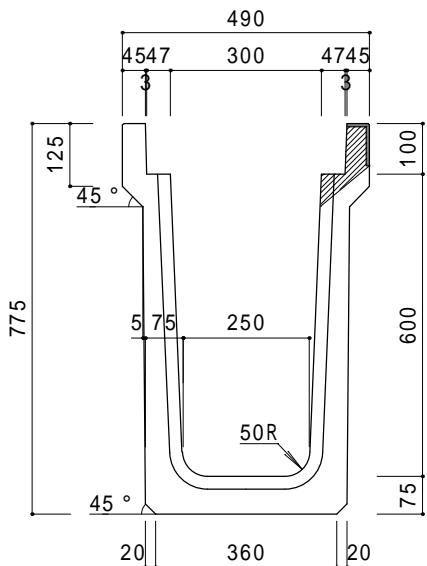

CH1-40-40

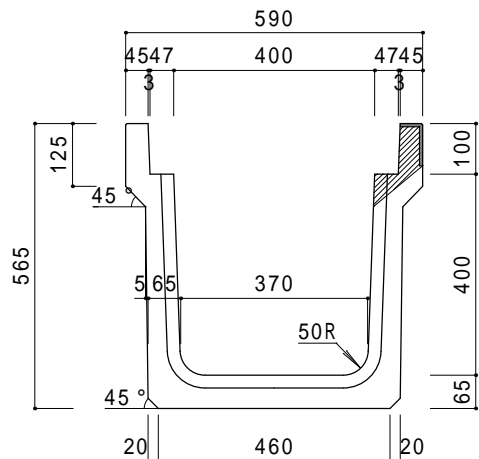

CH1-40-50

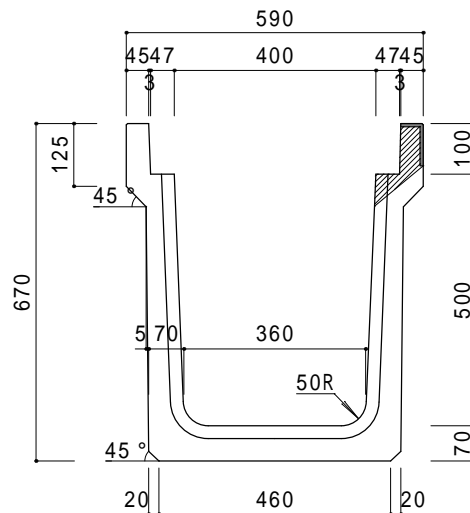

CH1-40-60

